

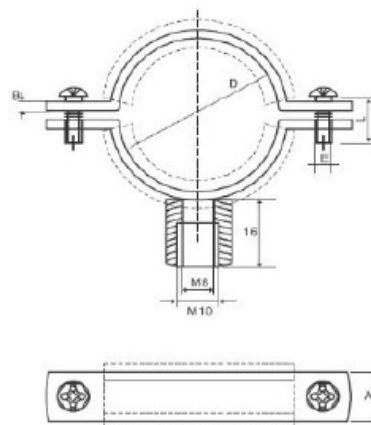







obejmy do rur nierdzewne INOX  
z gumą gwnt M9-M10 w nakrętce

abria2



OZNACZENIA



M	Ø	obejma w mm	A2
M8-M10 3/8"	18	15-19 mm	
M8-M10 1/2"	22	20-25 mm	
M8-M10 3/4" 900	28	26-30 mm	
M8-M10 1"	35	32-36 mm	
M8-M10 1 1/4"	40	38-43 mm	
M8-M10 1 1/2"	48	47-51 mm	
M8-M10	54	53-58 mm	
M8-M10 2"	60	60-64 mm	